





230V SLIDING GATE KIT

Up to 800kg @ 14m



We would always advise you to spec your jobs with safety edges. When you see this symbol it is imperative that at least one is used.



Code	Description	Quantity
801MS-0030   	BX708AGS - Automation complete with electronic board with programming display, built-in radio remote programming, speed control control and obstacle detection and mechanical limit switches for sliding gates up to 800 kg and 14 m in length	1
001 AF43S	Plug-in radio-frequency control card	1
806TS-0122	TOPD4RKS - Double frequency 4-button rolling code transmitter, black colour. 4,294,967,896 combinations.	2
001 TOP-A433N	Tuned Antenna.	1
001 DIR10 	Pair of 12 - 24 V AC - DC outdoor photocells – range 10 m.	1



BK708AGS

Up to 800 kg



Ideal for fitting onto sliding gates

- Operate gates up to 800 kg, all encoder controlled.
- Can fit magnetic limit-switches.
- Electronic board, with separate terminal blocks and display, to facilitate start-up and diagnosis phases. Storing for up to 250 different users.
- Radio programming Rolling code and integrated Key Code (Twin).
- The safety inputs can be configured to directly control the 8k2Ω resistive sensitive-safety edges.
- Management of the Rio series wireless security accessories using the dedicated plug-in accessory.
- Testing of safety circuits for CAT 2 safety products – whether wireless or not.
- Devices developed for connection to the cloud, via CAME Connect. Used to directly manage CAME key pads using the R800 accessory or connect CAME transponder selectors using the R700 accessory.

Dimensions (mm)

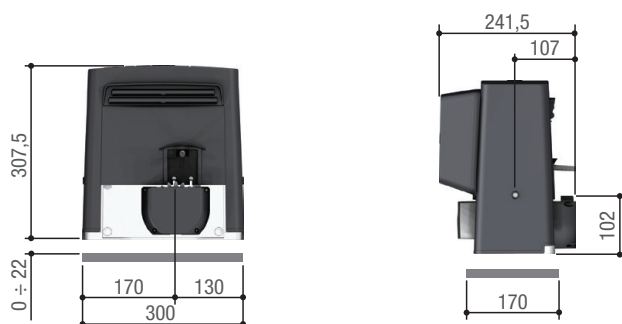

Operational limits

MODELS	801MS-0030
Max. length of leaf (m)	14
Max. weight of leaf (kg)	800

Technical characteristics

MODELS	801MS-0030
Protection rating (IP)	44
Power supply (V - 50/60 Hz)	230 AC
Power supply to motor (V)	230 AC 50/60 Hz
Absorption (A)	2,4
Power (W)	300
Maneuvering speed (m/min)	-
Duty/cycle (%)	30
Thrust (N)	800
Operating temperature (°C)	-20 ÷ +55
Motor's heat protection (°C)	150

ACCESSORIES

TOPA433N

Tuned Antenna for 433.92Mhz



Dimensions (mm)

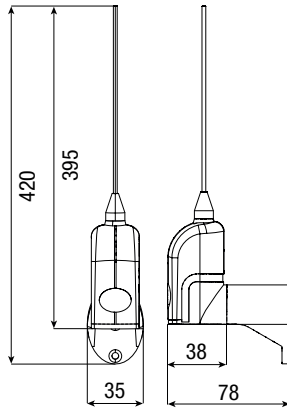

Operational limits

MODELS	TA433N
Max. range of radio (m)	50 ÷ 150

Technical characteristics

MODELS	TA433N
Radio signal frequency (Mhz)	433.92Mhz

AF43S

Radio frequency control card 433.92MHz

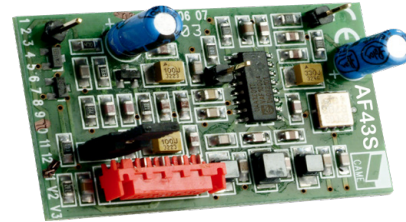

- Dip-switches for code and function selection
- Function enabling button
- Red signalling LED
- Green signalling LED
- Backup board
- Plug-in connector on receivers

Technical characteristics

MODELS	AF43S
Power supply (V±10%)	5
Current draw (mA)	5.5
Encoding type	ASK
Operating temperature (°C)	-20 to +55
Sensitivity (dBm)	-107

TOPD4RKS

Rolling code 433.92 and 868.35 Mhz radio control



Dimensions (mm)

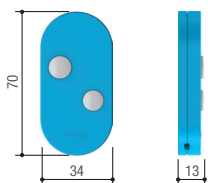

- Manages several operators on different frequencies.
- One device to manage two frequencies, that is, 433.92 MHz and 868.35 MHz.
- More secure thanks to the dynamic code.
- Uses only one CR2032 battery.
- Flat battery alert
- No setting required when selecting the frequency
- Comes in two-channel and four-channel versions.
- Available in six different colours.
- Surface-mounted receiver modules 806RV-0010 and 806RV-0020 - GAME KEY compatible.

Operational limits

MODELS	806TS-0122
Max. range of radio (m)	50 ÷ 150

Technical characteristics

MODELS	806TS-0122
Combinations	4.294.967.896
Radio signal frequency (Mhz)	433,92 - 868,35
Operating temperature (°C)	-20 ÷ +55
Material	POLYCARBONATE

DIR10

Photocells



Dimensions (mm)

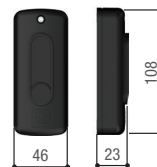

- Control the gate's area of movement
- Infrared beam, even synchronised, to prevent any external signal disturbances.
- For the DIR series photocells, there is a double-height post, and a new PVC version of the post, for installing in entry and exit points where heavy vehicles drive through.
- High degree of protection against weathering.

Operational limits

MODELS	DIR10
Max. range of radio (m)	10

Technical characteristics

MODELS	DIR10
Protection rating (IP)	54
Power supply (V)	12 - 24 AC - DC
Absorption	60
Max. rating of 24 V (A) relay contacts	0,5
Operating temperature (°C)	-20 ÷ +55
Material	ABS - POLYCARBONATE